

1-6GHz Low Noise Amplifier

P/N: QLLNA0106GB30



Description:

The amplifier is a low noise amplifier with a typical small signal gain of 29 ± 1 dB and a typical noise figure of 0.9dB across the frequency range of 1 to 6 GHz. The typical output power P-1 5dBm. The DC power requirement for the amplifier is +5~15VDC/100 mA. Accept customization according to different needs.



- Radar Systems
- Communication Systems
- Receivers Systems

Electrical Specifications (+25°C) :

Parameter	Min.	Typ.	Max.	Units
Frequency Range		1-6		GHz
Gain		29 ± 1		dB
Gain Flatness		± 0.5	± 1.0	dB
Input VSWR			2.0	-
Output VSWR			2.0	-
Output Power for (P1dB)	5			dBm
Noise Figure		0.9	1.4	dB
Input Max Power(no damage)			20	dBm
DC Current (Vcc=+5-15V)			100	mA
Impedance		50		Ω
Input/Output Connector		SMA-K/SMA-K		
Material		Aluminium		
Weight		-		
Package Sealing		General Sealing (Standard)		

Environmental Specifications:

- ※ Operational Temperature -25°C~+85°C
- ※ Storage Temperature -55°C~+125°C



OBSERVE
PRECAUTIONS ELECTROSTATIC
SENSITIVE DEVICES

MICZEN THCHNOLOGIES CO.,LTD.

Phone: +86 28 65003621 | E-mail: sales@miczen.com | Web: www.miczen.com

1-6GHz Low Noise Amplifier

P/N: QLLNA0106GB30



■ Outline Drawing

All Dimensions in mm (inches) Tolerance ± 0.25 (0.01)

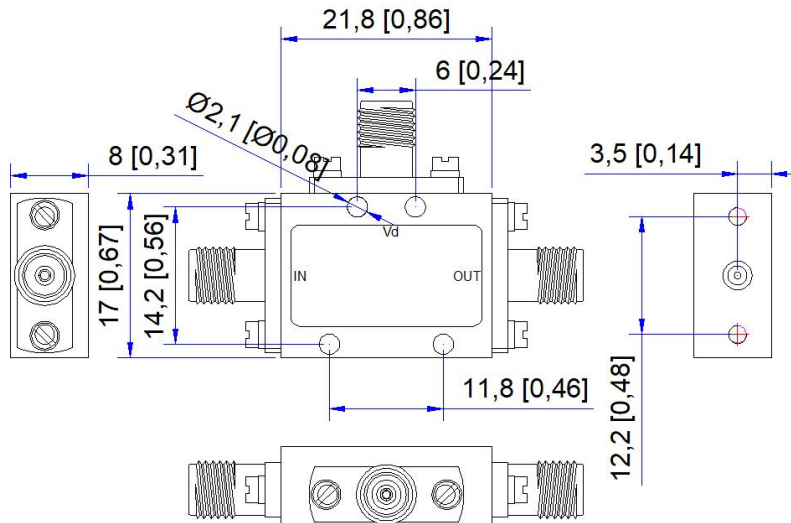

*****Heat Sink required during operation*****

NOTE:

1. The product is designed to meet environmental ratings but not tested. If you need to test environmental condition, please contact our sales department.
2. Miczen technologies co., Ltd. reserves the right to change the above information without notice.

MICZEN THCHNOLOGIES CO.,LTD.

Phone: +86 28 65003621 | E-mail: sales@miczen.com | Web: www.miczen.com