

# 2-40GHz 16dB Directional Coupler

P/N: MZD160240GH



## Description:

MZD160240GH is a 16dB single directional coupler with a typical insertion Loss of 1.0dB and a typical directivity of 12dB across the frequency range of 2 to 40GHz. The directional coupler can reach handling power 20W. Accept customization according to different needs.

- Radar Systems
- Communication Systems
- Receivers Systems

## Electrical Specifications ( +25°C ) :

Parameter	Min.	Typ.	Max.	Units
Frequency Range		2-40		GHz
Insertion Loss		1.0	1.5	dB
Nominal Coupling		16		dB
Coupling Accuracy		±0.3	±0.5	dB
Frequency Sensitivity		±0.8	±1.0	dB
Directivity	11	12		dB
VSWR			1.6	-
Power Handling		20		W
Impedance		50		Ω
Connector		2.92mm-Female		
Material		Aluminum		
Weight		35.4g / 1.25 Ounces Max.		
Finish		Black Paint(Standard)		

## Environmental Specifications:

- ※ Operational Temperature -55°C~+85°C
- ※ Storage Temperature -55°C~+100°C



MICZEN THCHNOLOGIES CO.,LTD.

Phone: +86 28 65003621 | E-mail: sales@miczen.com | Web: www.miczen.com

# 2-40GHz 16dB Directional Coupler

P/N: MZD160240GH



## Typical Performance (Room Temp. +25°C, RH: 50%)

### IN-Port VSWR

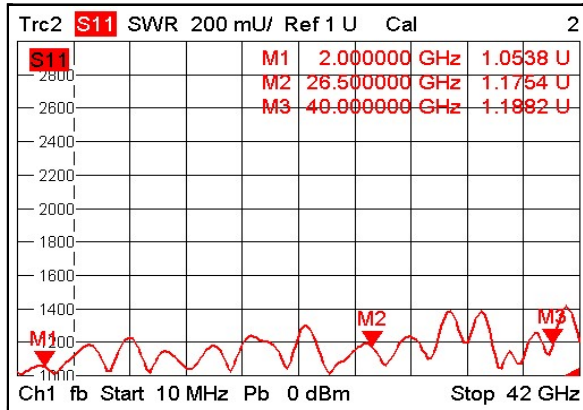

### OUT-Port VSWR

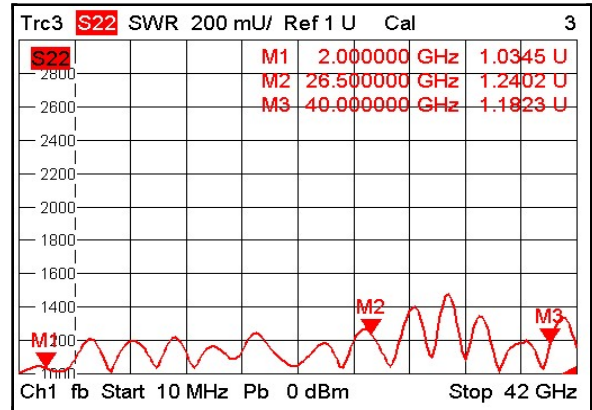

### Coupling-Port VSWR

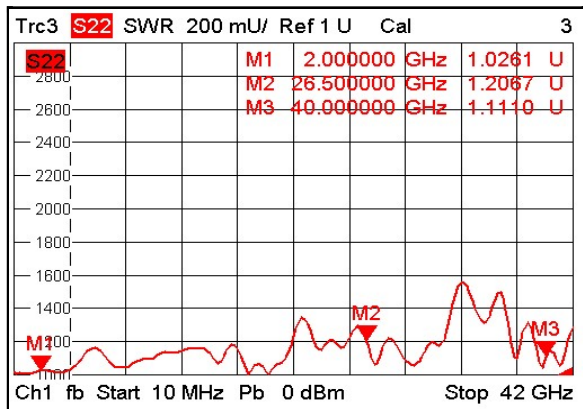

### Insertion Loss

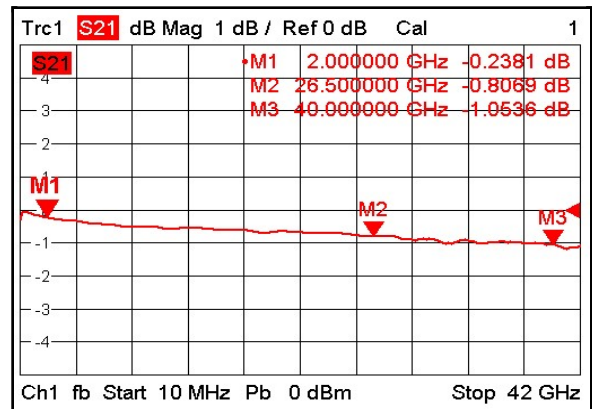

### Coupling

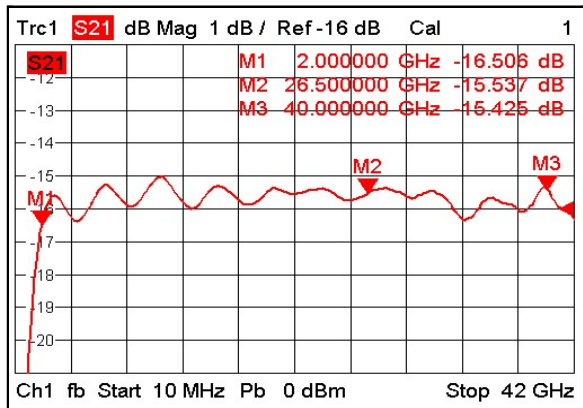

### Directivity

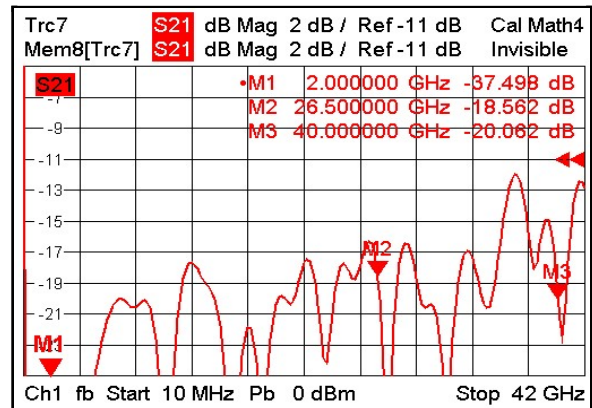

MICZEN THCHNOLOGIES CO.,LTD.

Phone: +86 28 65003621 | E-mail: sales@miczen.com | Web: www.miczen.com

# 2-40GHz 16dB Directional Coupler

P/N: MZD160240GH



## ■ Outline Drawing

All Dimensions in mm (inches) Tolerance  $\pm 0.25$  (0.01)

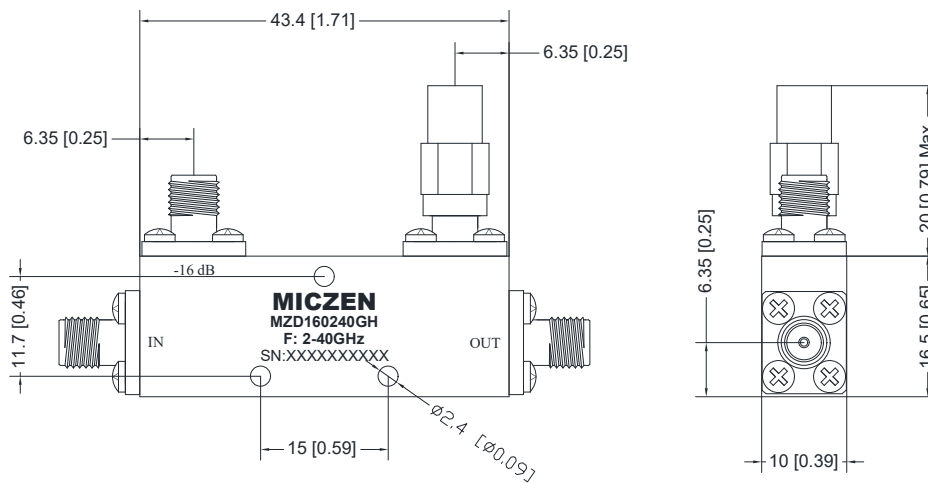

### NOTE:

1. The product is designed to meet environmental ratings but not tested. If you need to test environmental condition, please contact our sales department.
2. Miczen technologies co., Ltd. reserves the right to change the above information without notice.

MICZEN THCHNOLOGIES CO.,LTD.

Phone: +86 28 65003621 | E-mail: sales@miczen.com | Web: www.miczen.com