

6-50GHz 13dB Directional Coupler

P/N: MZD130650GH



Description:

MZD130650GH is a 13dB single directional coupler with a typical insertion Loss of 1.2dB and a typical directivity of 13dB across the frequency range of 6 to 50GHz. The directional coupler can reach handling power 20W. Accept customization according to different needs.

- Radar Systems
- Communication Systems
- Receivers Systems

Electrical Specifications (+25°C) :

Parameter	Min.	Typ.	Max.	Units
Frequency Range		6-50		GHz
Insertion Loss		1.2	1.5	dB
Nominal Coupling		13		dB
Coupling Accuracy		±0.7	±0.9	dB
Frequency Sensitivity		±0.4	±0.8	dB
Directivity	10	13		dB
VSWR		1.5	1.8	-
Power Handling		20		W
Impedance		50		Ω
Connector		2.4mm-Female		
Material		Aluminum		
Weight		30 g / 1.06 Ounces Max.		
Finish		Black Paint(Standard)		

Environmental Specifications:

- ※ Operational Temperature -55°C~+85°C
- ※ Storage Temperature -55°C~+100°C



MICZEN THCHNOLOGIES CO.,LTD.

Phone: +86 28 65003621 | E-mail: sales@miczen.com | Web: www.miczen.com

6-50GHz 13dB Directional Coupler

P/N: MZD130650GH



Typical Performance (Room Temp. +25°C, RH: 50%)

IN-Port VSWR

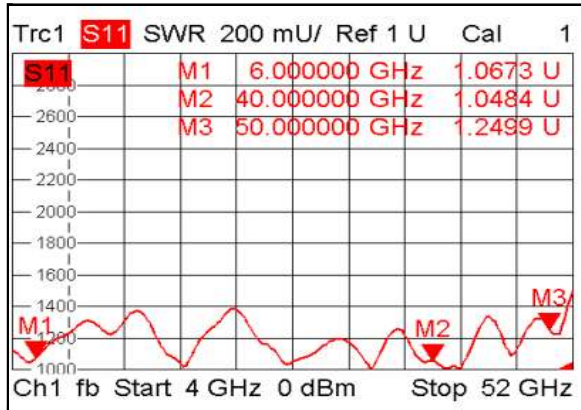

OUT-Port VSWR

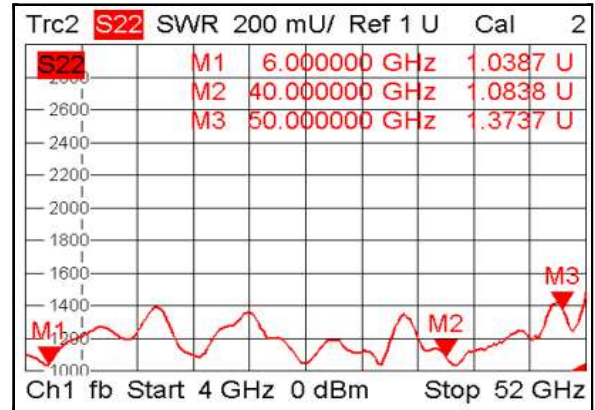

Coupling-Port VSWR

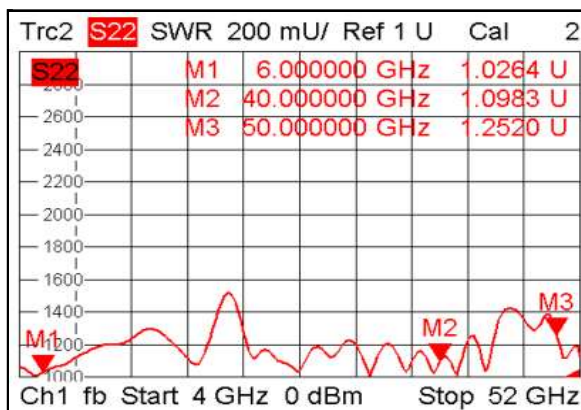

Insertion Loss

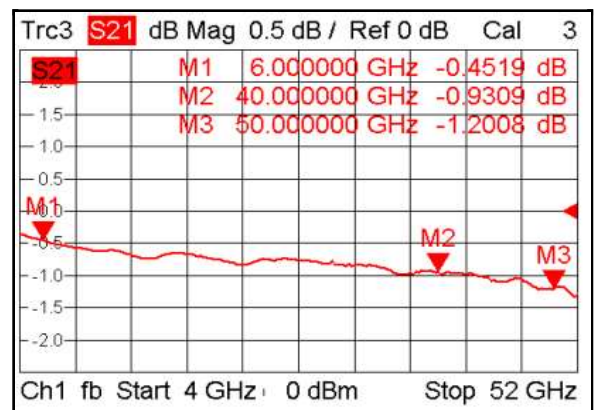

Coupling

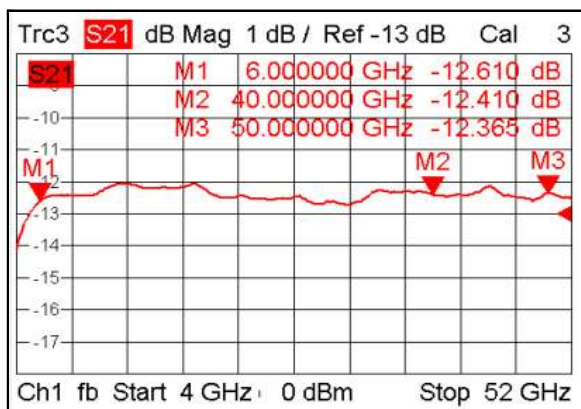

Directivity

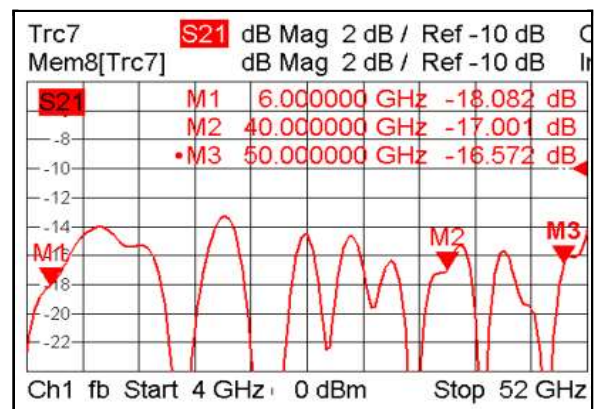

MICZEN TECHNOLOGIES CO.,LTD.

Phone: +86 28 65003621 | E-mail: sales@miczen.com | Web: www.miczen.com

6-50GHz 13dB Directional Coupler

P/N: MZD130650GH



Outline Drawing

All Dimensions in mm (inches) Tolerance ± 0.25 (0.01)

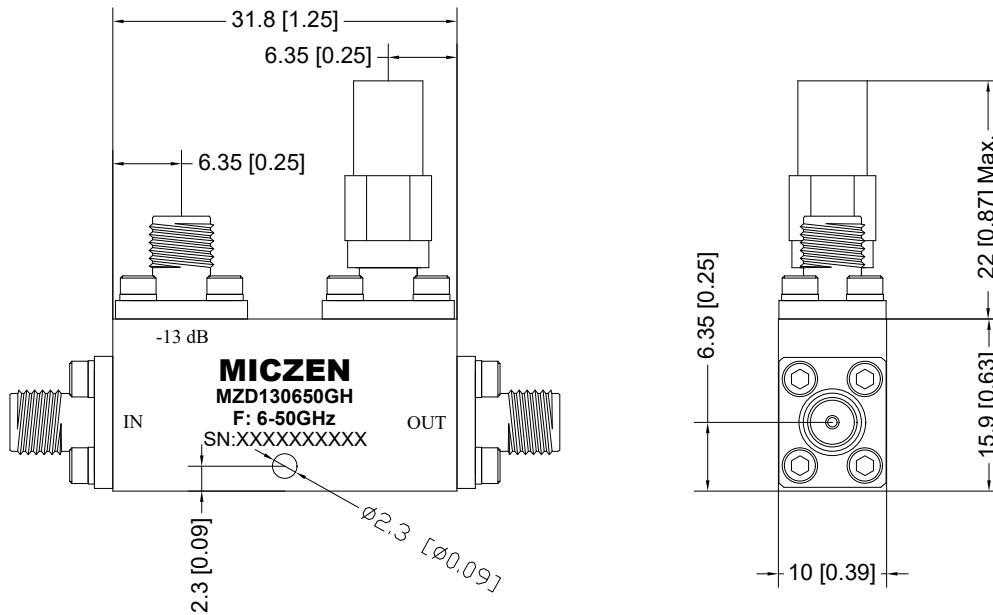

NOTE:

1. The product is designed to meet environmental ratings but not tested. If you need to test environmental condition, please contact our sales department.
2. Miczen technologies co., Ltd. reserves the right to change the above information without notice.

MICZEN THCHNOLOGIES CO.,LTD.

Phone: +86 28 65003621 | E-mail: sales@miczen.com | Web: www.miczen.com