

1-26.5GHz 13dB Directional Coupler

P/N: MZD130127GH



Description:

MZD130127GH is a 13dB single directional coupler with a typical insertion Loss of 1.1dB and a typical directivity of 14dB across the frequency range of 1 to 26.5GHz. The directional coupler can reach handling power 20W. Accept customization according to different needs.

- Radar Systems
- Communication Systems
- Receivers Systems

Electrical Specifications (+25°C) :

| Parameter | Min. | Typ. | Max. | Units |
|-----------------------|------|--------------------------|------|-------|
| Frequency Range | | 1-26.5 | | GHz |
| Insertion Loss | | 1.1 | 1.4 | dB |
| Nominal Coupling | | 13 | | dB |
| Coupling Accuracy | | ±0.3 | ±0.7 | dB |
| Frequency Sensitivity | | ±0.8 | ±1.0 | dB |
| Directivity | 13 | 14 | | dB |
| VSWR | | | 1.6 | - |
| Power Handling | | 20 | | W |
| Impedance | | 50 | | Ω |
| Connector | | SMA-Female | | |
| Material | | Aluminum | | |
| Weight | | 44.2g / 1.56 Ounces Max. | | |
| Finish | | Black Paint(Standard) | | |

Environmental Specifications:

- ※ Operational Temperature -55°C~+85°C
- ※ Storage Temperature -55°C~+100°C



MICZEN THCHNOLOGIES CO.,LTD.

Phone: +86 28 65003621 | E-mail: sales@miczen.com | Web: www.miczen.com

1-26.5GHz 13dB Directional Coupler

P/N: MZD130127GH



Typical Performance (Room Temp. +25°C, RH: 50%)

IN-Port VSWR

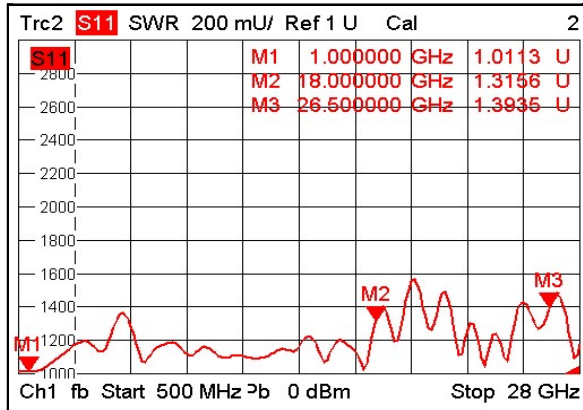

OUT-Port VSWR

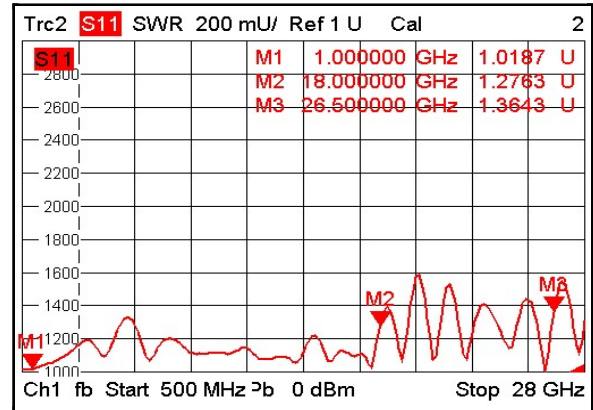

Coupling-Port VSWR

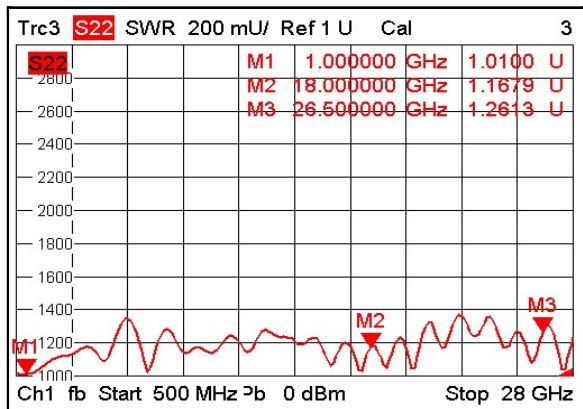

Insertion Loss

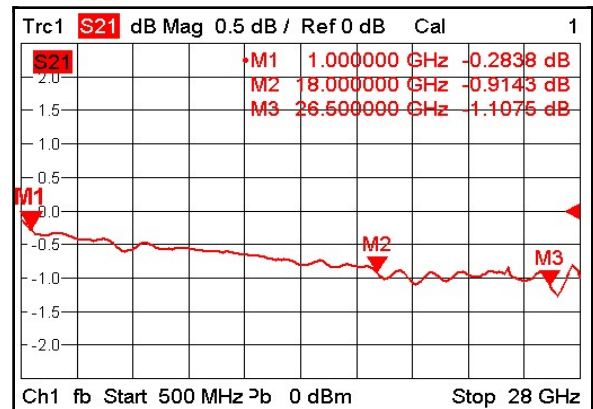

Coupling

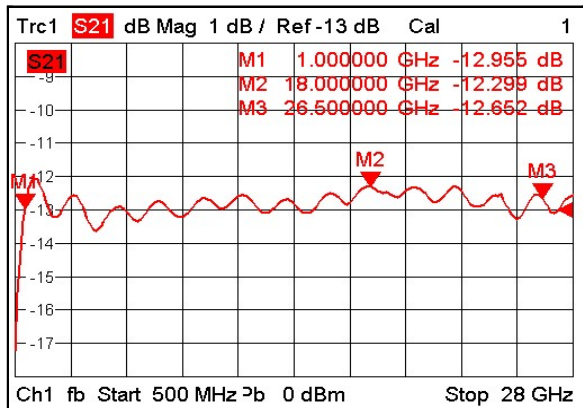

Directivity

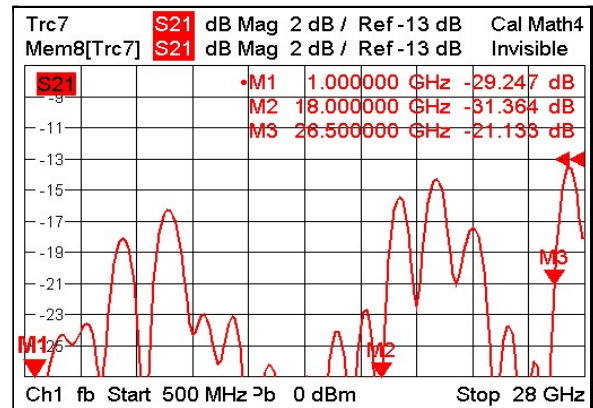

MICZEN TECHNOLOGIES CO.,LTD.

Phone: +86 28 65003621 | E-mail: sales@miczen.com | Web: www.miczen.com

1-26.5GHz 13dB Directional Coupler

P/N: MZD130127GH



Outline Drawing

All Dimensions in mm (inches) Tolerance ± 0.25 (0.01)

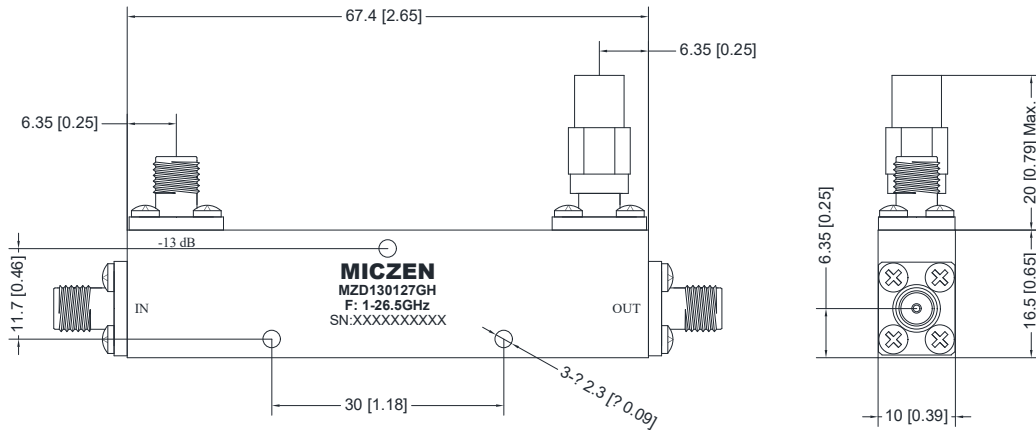

NOTE:

1. The product is designed to meet environmental ratings but not tested. If you need to test environmental condition, please contact our sales department.
2. Miczen technologies co., Ltd. reserves the right to change the above information without notice.

MICZEN THCHNOLOGIES CO.,LTD.

Phone: +86 28 65003621 | E-mail: sales@miczen.com | Web: www.miczen.com