

Features:

- Ultra Wide Band
- Low Insertion Loss
- High Directivity
- Rush Delivery
- Fast Response
- Customization Available Upon Request

Electronic Specifications, TA = +25 ° C, 50 Ohm System

Parameter	Min.	Typ.	Max	Units
Frequency Range	2-8			GHz
Insertion Loss (Excl Coupling)			0.8	dB
Normal Coupling	6			dB
COUPLING ACCURACY			±1.0	dB
Frequency Sensitivity			±1.0	dB
Directivity	20			dB
VSWR			1.3	
Power Handling Capability	50			W
Weight				g
Impedance	50			Ω
Input Connector	N-FEMALE			-
Output Connector	N-FEMALE			
Material	Aluminum			-
Finishing	Black Paint			

Environmental Conditions:

Operational Temperature	-45°C~+85°C	Vibration	25g rms (15 degree 2KHz) endurance, 1 hour per axis
Storage Temperature	-55°C~+125°C	Shock	20G for 11msc half sin wave,3 axis both directions
Executive Standard	GJB9001	Humidity	100% RH at 35c, 95%RH at 40°C

Outline Drawing:

All Dimensions in mm (inches) Tolerance ± 0.25 (0.01)

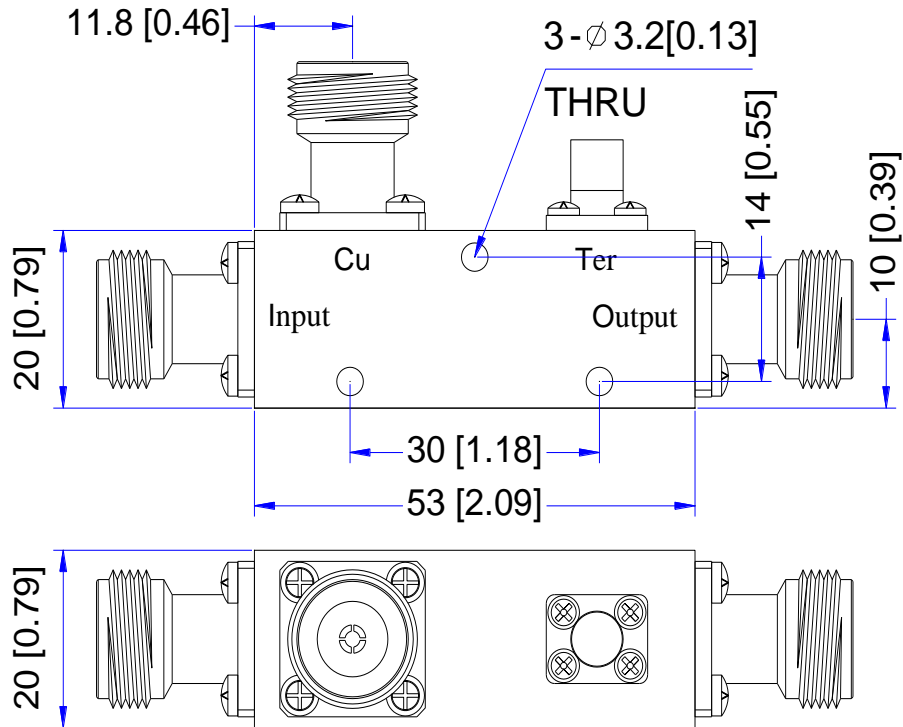

COMPANY STATEMENT:

Information provided by Miczen Technologies Co.,Ltd. is believed to be accurate and reliable. However, no responsibility is assumed by Miczen Technologies Co.,Ltd. for its use. Specifications subject to change without notice.